



UNIVERSITY OF CAMBRIDGE INTERNATIONAL EXAMINATIONS
 General Certificate of Education
 Advanced Subsidiary Level and Advanced Level

CANDIDATE
 NAME

CENTRE
 NUMBER

--	--	--	--

CANDIDATE
 NUMBER

--	--	--	--



PHYSICS

9702/35

Paper 3 Advanced Practical Skills 1

May/June 2012

2 hours

Candidates answer on the Question Paper.

Additional Materials: As listed in the Confidential Instructions.

READ THESE INSTRUCTIONS FIRST

Write your Centre number, candidate number and name on all the work you hand in.

Write in dark blue or black pen.

You may use a soft pencil for any diagrams, graphs or rough working.

Do not use staples, paper clips, highlighters, glue or correction fluid.

DO NOT WRITE IN ANY BARCODES.

Answer **both** questions.

You will be allowed to work with the apparatus for a maximum of one hour for each question.

You are expected to record all your observations as soon as these observations are made, and to plan the presentation of the records so that it is not necessary to make a fair copy of them.

You may lose marks if you do not show your working or if you do not use appropriate units.

Additional answer paper and graph paper should be used only if it becomes necessary to do so.

You are reminded of the need for good English and clear presentation in your answers.

At the end of the examination, fasten all your work securely together.

The number of marks is given in brackets [] at the end of each question or part question.

For Examiner's Use	
1	
2	
Total	

This document consists of **10** printed pages and **2** blank pages.



You may not need to use all of the materials provided.

For
Examiner's
Use

1 In this experiment, you will investigate how the current in a circuit depends on the resistance of the circuit.

(a) Set up the circuit as shown in Fig. 1.1. The crocodile clip should be positioned so that **three** of the resistors from the chain are included in the circuit.

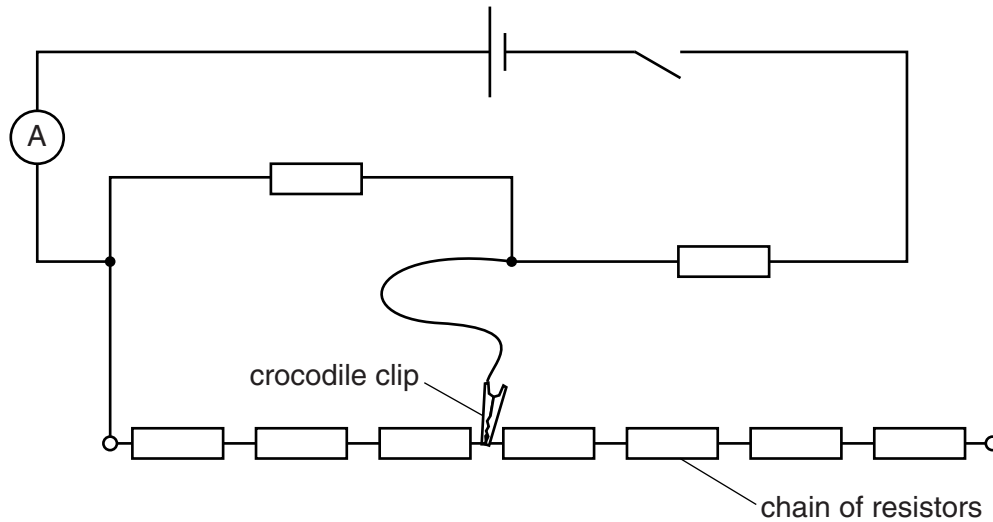

Fig. 1.1

All the resistors have the same value of resistance R .

- (b) (i) Close the switch.
 (ii) Record the ammeter reading I and the number n of resistors from the chain included in the circuit.

$I =$

$n =$

[1]

- (iii) Open the switch.

- (c) By attaching the crocodile clip to different junctions and terminals on the chain of resistors, repeat (b) until you have six sets of readings of I and n .

Include values of $\frac{(n+1)}{I}$ in your table.

For
Examiner's
Use

[10]

- (d) (i) Plot a graph of $\frac{(n+1)}{I}$ on the y -axis against n on the x -axis. [3]

(ii) Draw the straight line of best fit. [1]

(iii) Determine the gradient and y -intercept of this line.

gradient =

y -intercept =

[2]

For
Examiner's
Use

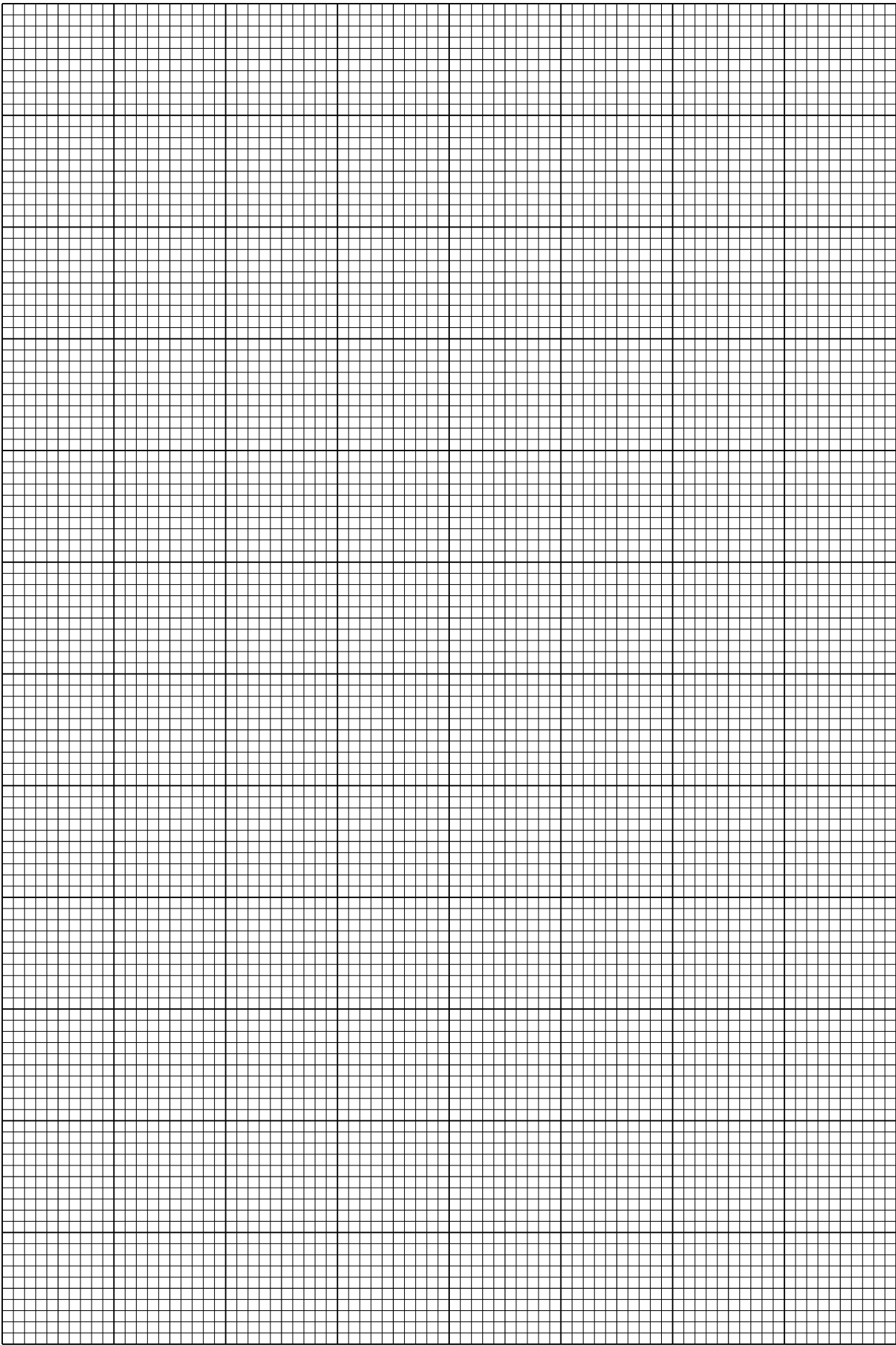

- (e) It is suggested that the relationship between I and n is

$$\frac{(n+1)}{I} = Pn + Q$$

where P and Q are constants.

Use your answers in (d)(iii) to determine values for P and Q .

$$P = \dots\dots\dots$$

$$Q = \dots\dots\dots$$

[1]

For
Examiner's
Use

- (f) Disconnect the circuit.
Connect the voltmeter across the cell.
Measure and record the voltage V across the cell.

$$V = \dots\dots\dots \text{ V [1]}$$

- (g) The constant P is related to R and V by

$$P = \frac{2R}{V}$$

Using your answers in (e) and (f), calculate a value for R .

$$R = \dots\dots\dots [1]$$

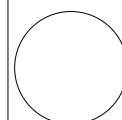

You may not need to use all of the materials provided.

For
Examiner's
Use

- 2 In this experiment, you will investigate how the rotational motion of an object depends on its mass.
- (a) Mould the modelling clay into a solid disc that is identical in shape to that of the 100g slotted mass. You will not need to use all of the modelling clay. The modelling clay should keep this shape throughout the experiment.
- (b) (i) Place the metre rule on the pivot so that it balances, as shown in Fig. 2.1.

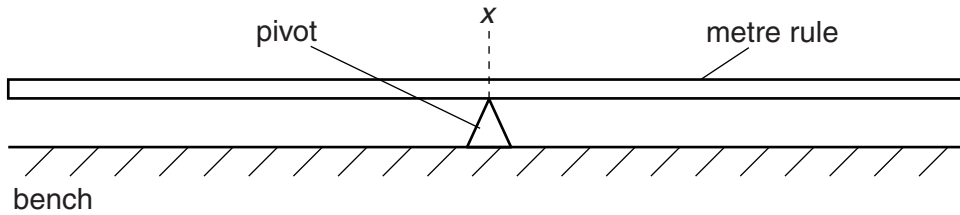

Fig. 2.1

- (ii) Record the metre rule reading x at the pivot.

$x = \dots\dots\dots$ [1]

- (iii) Remove the metre rule from the pivot and lay it flat on the bench.

- (c) (i) Place the disc you made in (a) at the 100cm end of the metre rule as shown in Fig. 2.2.

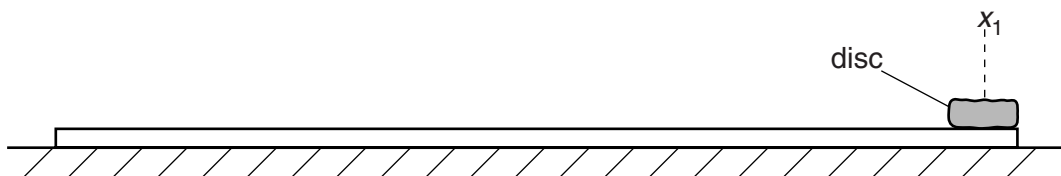

Fig. 2.2

- (ii) Record the metre rule reading x_1 at the centre of the disc.

$x_1 = \dots\dots\dots$ [1]

- (iii) Calculate the distance d_1 , where $d_1 = (x_1 - x)$.

$d_1 = \dots\dots\dots$ [1]

- (iv) Estimate the percentage uncertainty in your value of d_1 .

For
Examiner's
Use

percentage uncertainty = [1]

- (d) (i) **With the disc still at x_1** , carefully place the metre rule so that the pivot is again under your value of x on the metre rule from (b)(ii). Use the 100g mass to balance the rule, as shown in Fig. 2.3.

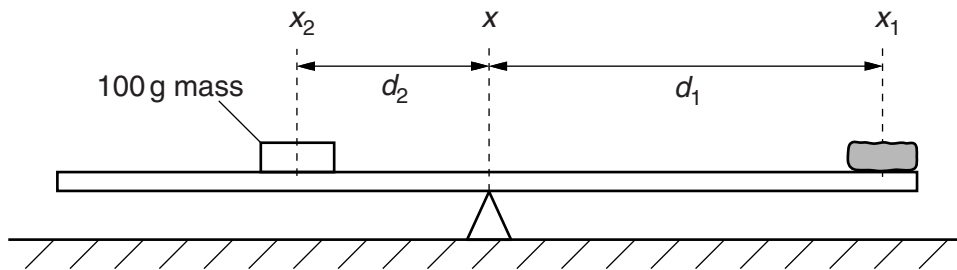

Fig. 2.3

- (ii) Record the metre rule reading x_2 at the centre of the 100g mass.

$x_2 = \dots\dots\dots$ [1]

- (iii) Calculate the distance d_2 , where $d_2 = (x - x_2)$.

$d_2 = \dots\dots\dots$

- (iv) Carefully remove the 100g mass and disc from the rule.

- (e) (i) Place the 100 g mass on the wire hanger and suspend it from the rubber band, as shown in Fig. 2.4.

For
Examiner's
Use

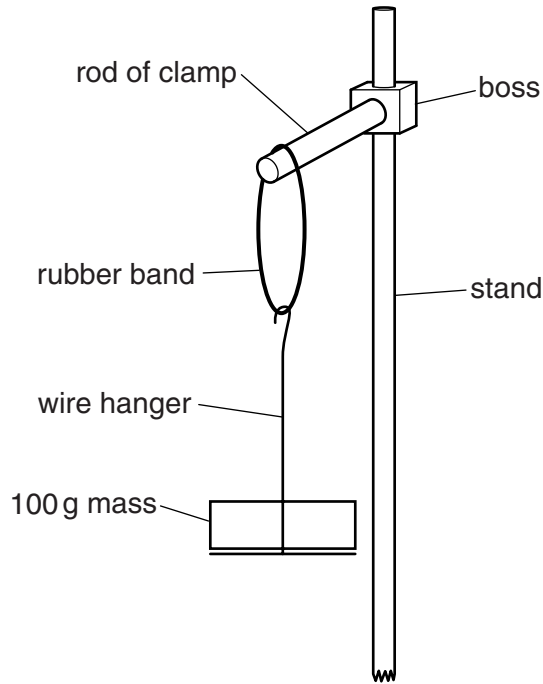

Fig. 2.4

- (ii) Hold the 100 g mass and slowly twist it horizontally through 90°.
 (iii) Release the 100 g mass and watch its movement.
 The mass completes one oscillation by moving as shown in Fig. 2.5.

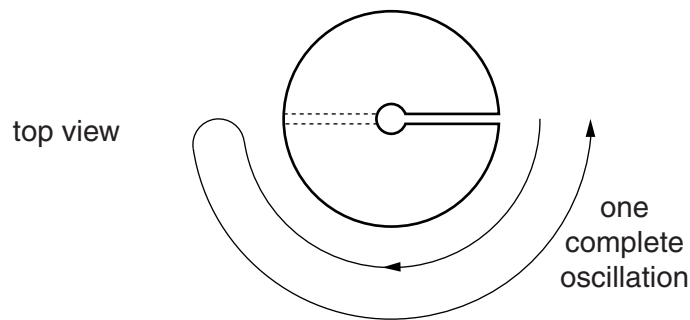

Fig. 2.5

The time taken for one complete oscillation is T .
 By timing several of these complete oscillations, determine an accurate value for T .

$T = \dots\dots\dots$ s [2]

(f) Repeat (e) using the disc.

For
Examiner's
Use

$T = \dots\dots\dots$ s [2]

(g) For an oscillating mass it is suggested that the relationship between T and d is

$$T^2 = \frac{k}{d}$$

where k is a constant.

(i) Using your data, complete the table in Fig. 2.6 and calculate two values of k .

object	distance from pivot	T/s	k
disc	$d_1 = \dots\dots\dots$	$\dots\dots\dots$	$\dots\dots\dots$
100 g mass	$d_2 = \dots\dots\dots$	$\dots\dots\dots$	$\dots\dots\dots$

Fig. 2.6

[1]

(ii) Justify the number of significant figures that you have given for your values of k .

.....

 [1]

(iii) Explain whether your results in (g)(i) support the suggested relationship.

.....

 [1]

(h) (i) Describe four sources of uncertainty or limitations of the procedure for this experiment.

For
Examiner's
Use

- 1.
.....
- 2.
.....
- 3.
.....
- 4.
.....

[4]



(ii) Describe four improvements that could be made to this experiment. You may suggest the use of other apparatus or different procedures.

- 1.
.....
- 2.
.....
- 3.
.....
- 4.
.....

[4]

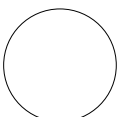

BLANK PAGE

Permission to reproduce items where third-party owned material protected by copyright is included has been sought and cleared where possible. Every reasonable effort has been made by the publisher (UCLES) to trace copyright holders, but if any items requiring clearance have unwittingly been included, the publisher will be pleased to make amends at the earliest possible opportunity.

University of Cambridge International Examinations is part of the Cambridge Assessment Group. Cambridge Assessment is the brand name of University of Cambridge Local Examinations Syndicate (UCLES), which is itself a department of the University of Cambridge.